

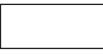



TRODAT PRINTY LINE_OVERLAY

4850 
10 NOV 2009

4908  Max. 14 x 6 mm
 $\frac{1}{4}'' \times \frac{9}{16}''$ ◆ 6/4908

4911  Max. 37 x 13 mm • $\frac{1}{2}'' \times \frac{17}{16}''$
◆ 6/4911

4921  Max. 11 x 11 mm
 $\frac{7}{16}'' \times \frac{7}{16}''$ ◆ 6/4921

Max. 24 x 4 mm • $\frac{3}{16}'' \times \frac{15}{16}''$ ◆ 6/4850

4910  Max. 25 x 8 mm
 $\frac{5}{16}'' \times 1''$ ◆ 6/4910

4813  10 NOV 2009
Max. 25 x 8 mm • $\frac{5}{16}'' \times 1''$ ◆ 6/4817

4912  Max. 46 x 17 mm • $\frac{5}{8}'' \times 1\frac{13}{16}''$ ◆ 6/4912

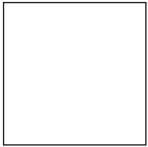
4922  Max. 19 x 19 mm
 $\frac{3}{4}'' \times \frac{3}{4}''$ ◆ 6/4922

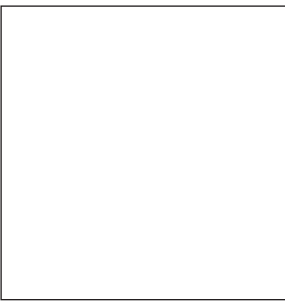
4924  Max. 39 x 39 mm • $1\frac{1}{2}'' \times 1\frac{1}{2}''$
◆ 6/4924

4750, 4941 (4760)  Max. 40 x 23 mm • $\frac{5}{16}'' \times 1\frac{9}{16}''$
◆ 6/4750

4913  Max. 57 x 21 mm • $\frac{13}{16}'' \times 2\frac{1}{4}''$ ◆ 6/4913

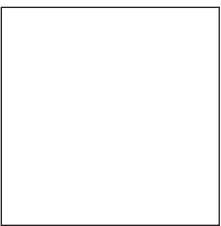
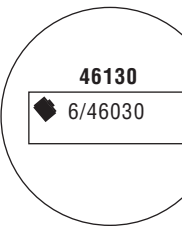
4923  Max. 29 x 29 mm • $1\frac{1}{8}'' \times 1\frac{1}{8}''$ ◆ 6/4923
46030  $\frac{6}{46030}$ $\frac{6}{46030}$
◆ 6/46030 $\varnothing 29 \text{ mm} \cdot 1\frac{1}{8}''$

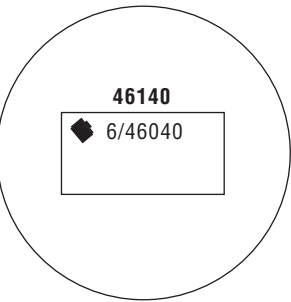
46040  $\frac{6}{46040}$ $\frac{6}{46040}$
◆ 6/46040 $\varnothing 39 \text{ mm} \cdot 1\frac{1}{2}''$

4915  Max. 69 x 24 mm • $\frac{15}{16}'' \times 2\frac{11}{16}''$ ◆ 6/4915

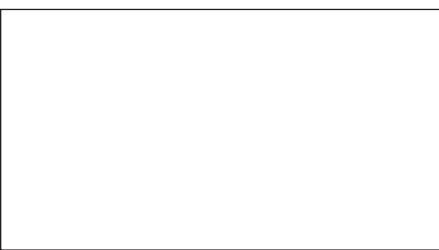
4928  Max. 59 x 32 mm • $1\frac{1}{4}'' \times 2\frac{5}{16}''$
◆ 6/4928

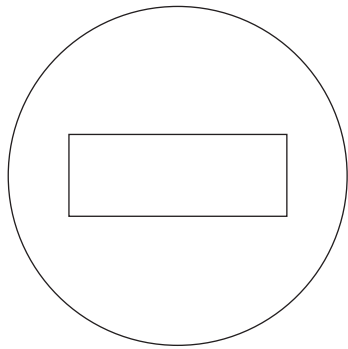
46145  $\frac{6}{46145}$ $\frac{6}{46145}$
◆ 6/46145 $\varnothing 44 \text{ mm} \cdot 1\frac{3}{4}''$

4916  Max. 69 x 9 mm • $\frac{5}{16}'' \times 2\frac{11}{16}''$ ◆ 6/4916

4926  $\frac{6}{4926}$ $\frac{6}{4926}$
◆ 6/4926
Max. 74 x 37 mm • $1\frac{7}{16}'' \times 2\frac{15}{16}''$ ◆ 6/4926

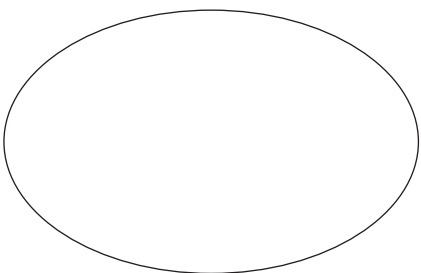
44055  Max. 54 x 34 mm • $1\frac{3}{8}'' \times 2\frac{1}{8}''$ ◆ 6/44055

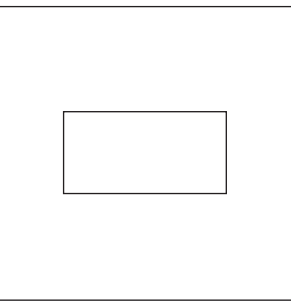
4724  Max. 39 x 39 mm • $1\frac{1}{2}'' \times 1\frac{1}{2}''$
◆ 6/4924

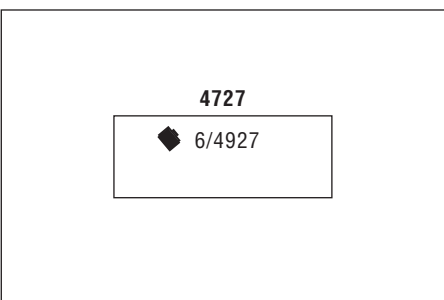
4927  $\frac{6}{4927}$ $\frac{6}{4927}$
◆ 6/4927
Max. 59 x 39 mm • $1\frac{1}{2}'' \times 2\frac{5}{16}''$ ◆ 6/4927

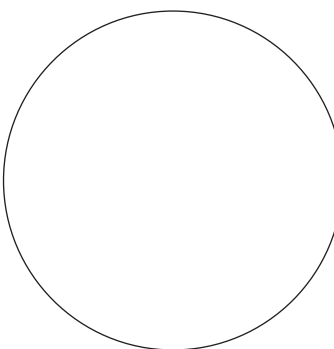
46045  $\frac{6}{46045}$ $\frac{6}{46045}$
◆ 6/46045 $\varnothing 44 \text{ mm} \cdot 1\frac{3}{4}''$

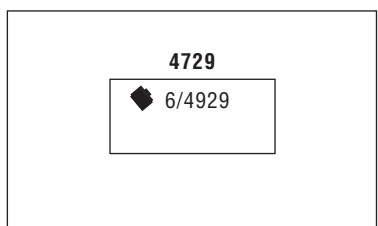
4929  $\frac{6}{4929}$ $\frac{6}{4929}$
◆ 6/4929
Max. 49 x 29 mm • $1\frac{1}{8}'' \times 1\frac{15}{16}''$ ◆ 6/4929

